

KSP 125-A

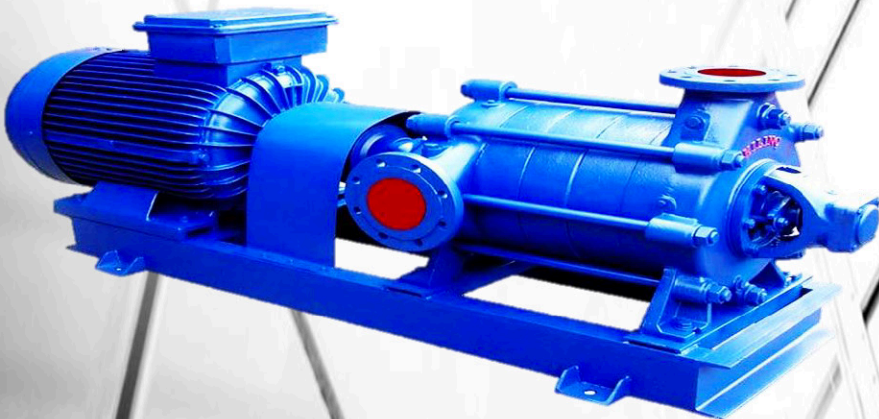
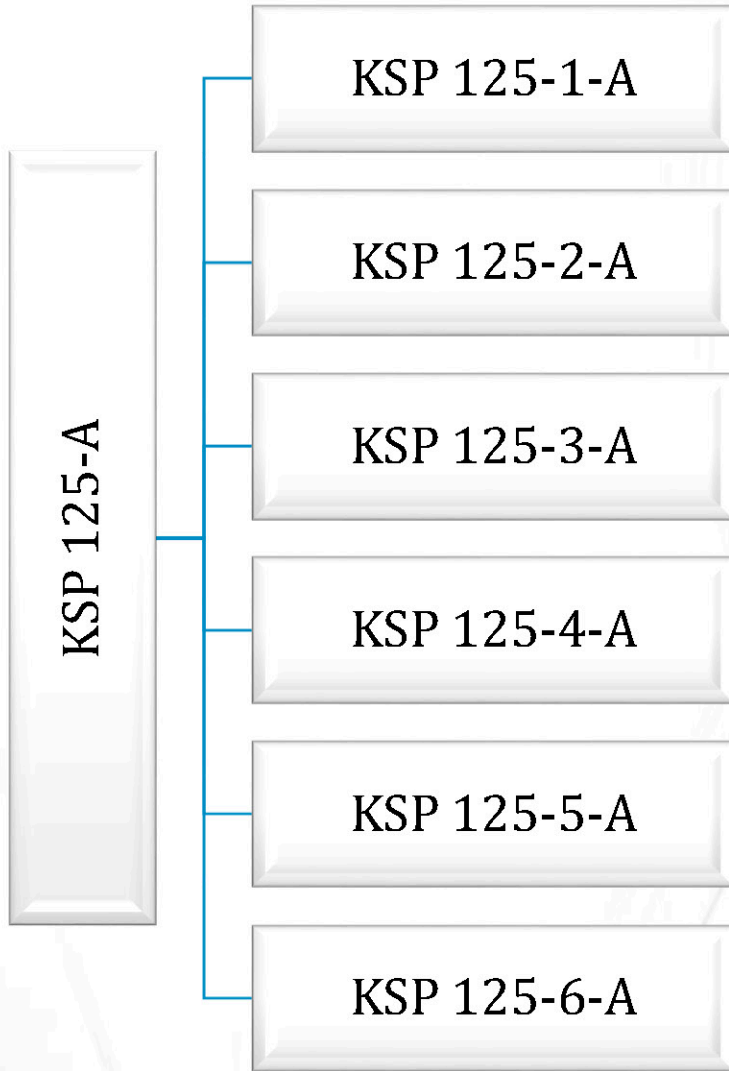

KSP 125-6/A

Pompa Bilgileri			
Pompa Tipi	KSP 125-6/A	Sızdırmazlık	Yumuşak Salmastra
Çark Çapı (mm) ϕ	290-305-325	Yoğunluk (kg/m ³)	1
Sıvı Cinsi	Su	Sıcaklık	-1°C - +110°C

Motor Bilgileri	
Güç (HP)	180
Voltaj (Volt)	380
Faz	3
Frekans (Hz)	50-60
Devir (rpm) (d/dk)	1500

ϕ 290		ϕ 305		ϕ 325	
Q (m ³ /h)	Hm (m)	Q (m ³ /h)	Hm (m)	Q (m ³ /h)	Hm (m)
40	174	40	196	40	220
80	160	80	182	80	208
120	135	120	157	120	185
160	98	160	120	160	151
180	75	200	72	200	105
				220	78

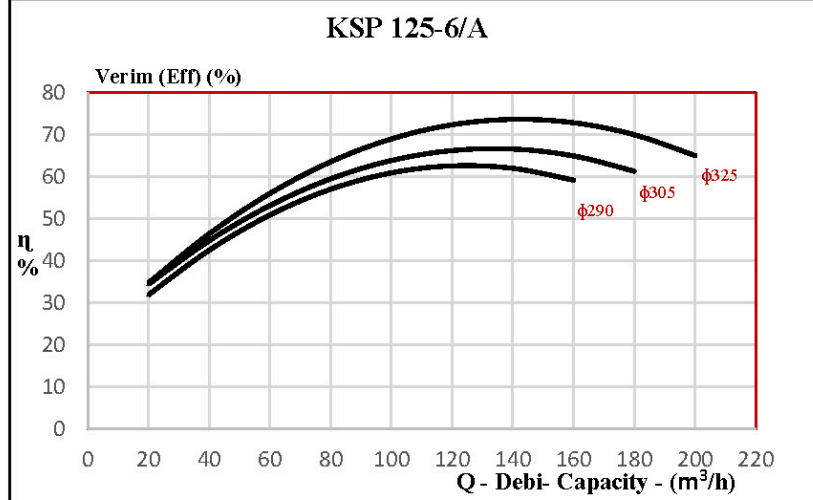
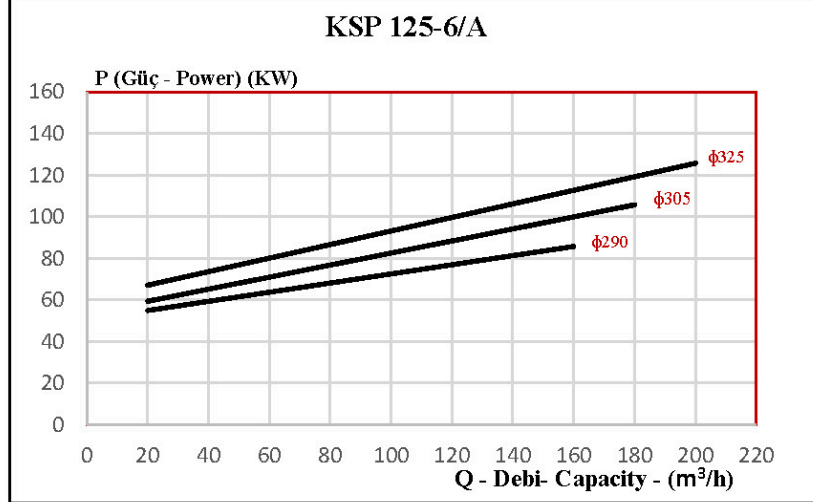
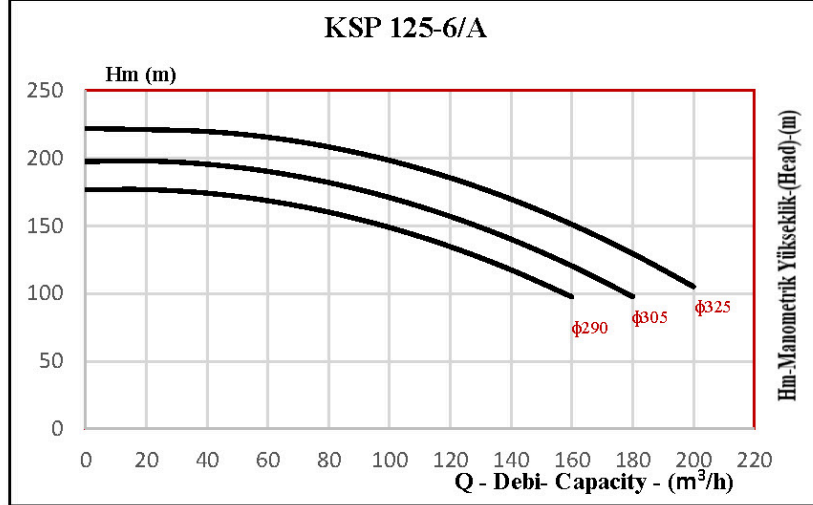
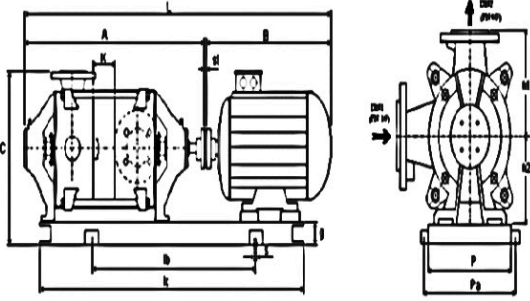

Pompa Tipi	KSP 125-6/A	
Kademe Sayısı	6	
Motor	HP	180
	Gövde	315 M4
Flanşlar	DN1 (Emme) (mm)	150
	DN2 (Basma) (mm)	125
Boyut Ölçüsü (mm)	A	1655
	B	1150
	C	850
	L	2805
	lc	2117
	lb	1717
	K	115
	P	630
	Pa	690
h1	375	
h2	300	
Kaplin Ölçüsü (ϕ) (mm)	250	
Ağırlık (kg)	1747	

KSP 125-5/A

Pompa Bilgileri				Motor Bilgileri	
Pompa Tipi	KSP 125-5/A	Sızdırmazlık	Yumuşak Salmastra	Güç (HP)	150
Çark Çapı (mm) ϕ	290-305-325	Yoğunluk (kg/m ³)	1	Voltaj (Volt)	380
Sıvı Cinsi	Su	Sıcaklık	-1°C - +110°C	Faz	3
				Frekans (Hz)	50-60
				Devir (rpm) (d/dk)	1500

ϕ 290		ϕ 305		ϕ 325	
Q (m ³ /h)	Hm (m)	Q (m ³ /h)	Hm (m)	Q (m ³ /h)	Hm (m)
40	145	40	163	40	183
80	133	80	152	80	174
120	112	120	131	120	155
160	81	160	100	160	126
180	62	200	60	200	88
				220	65

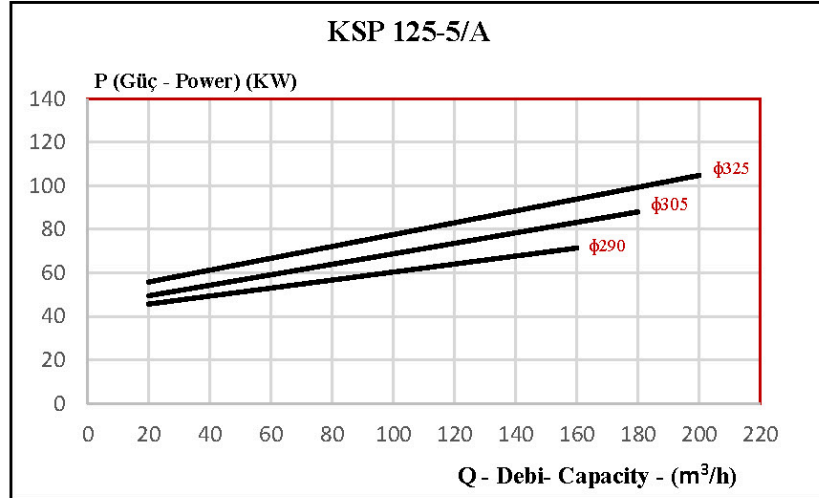
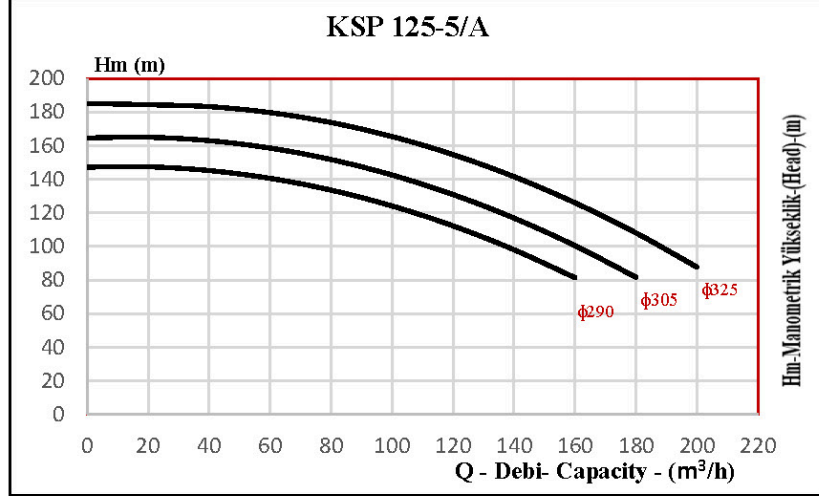
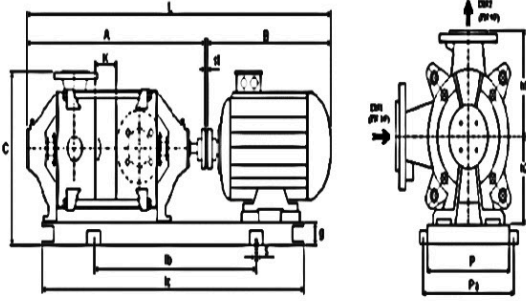

Pompa Tipi	KSP 125-5/A	
Kademe Sayısı	5	
Motor	HP	150
	Gövde	315 S4
Flanşlar	DN1 (Emme) (mm)	150
	DN2 (Basma) (mm)	125
Boyut Ölçüsü (mm)	A	1540
	B	1150
	C	850
	L	2690
	lc	1977
	lb	1577
	K	115
	P	630
	Pa	690
	h1	375
h2	300	
Kaplin Ölçüsü (ϕ) (mm)	225	
Ağırlık (kg)	1319	

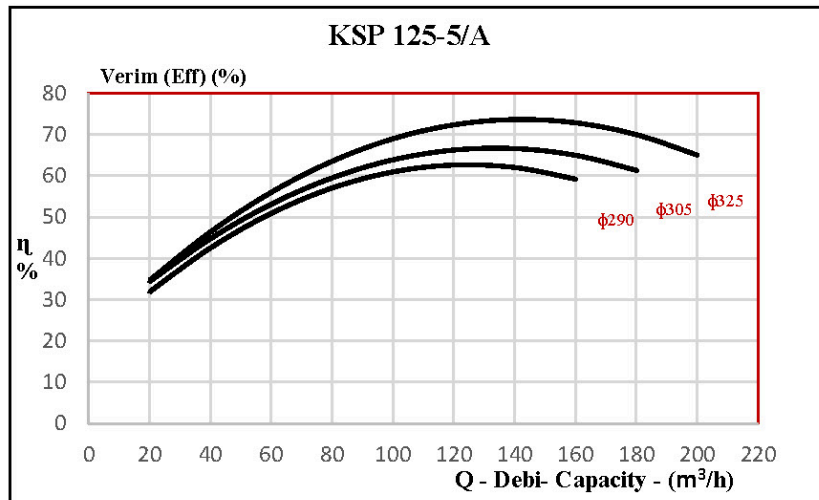

KSP 125-4/A

Pompa Bilgileri				Motor Bilgileri	
Pompa Tipi	KSP 125-4/A	Sızdırmazlık	Yumuşak Salmastra	Güç (HP)	100-125
Çark Çapı (mm) ϕ	290-305-325	Yoğunluk (kg/m ³)	1	Voltaj (Volt)	380
Sıvı Cinsi	Su	Sıcaklık	-1°C - +110°C	Faz	3
				Frekans (Hz)	50-60
				Devir (rpm) (d/dk)	1500

ϕ 290		ϕ 305		ϕ 325	
Q (m ³ /h)	Hm (m)	Q (m ³ /h)	Hm (m)	Q (m ³ /h)	Hm (m)
40	116	40	130	40	147
80	107	80	121	80	139
120	90	120	105	120	124
160	65	160	80	160	101
180	50	200	48	200	70
				220	52

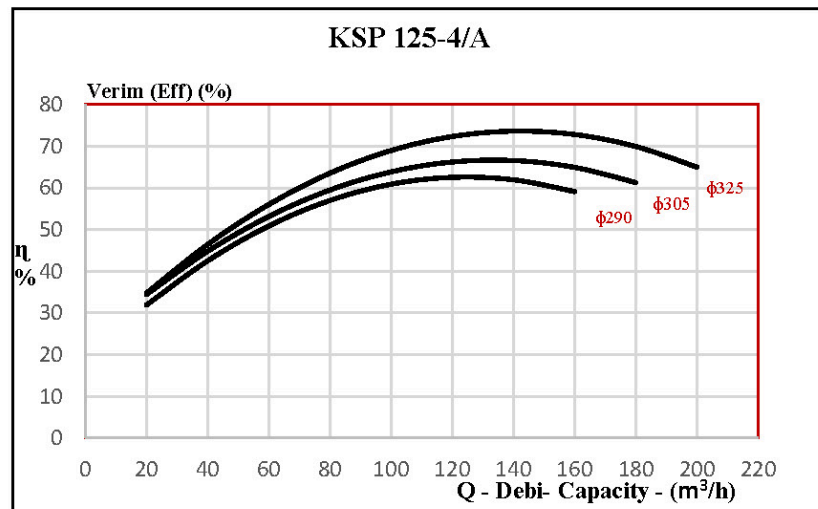
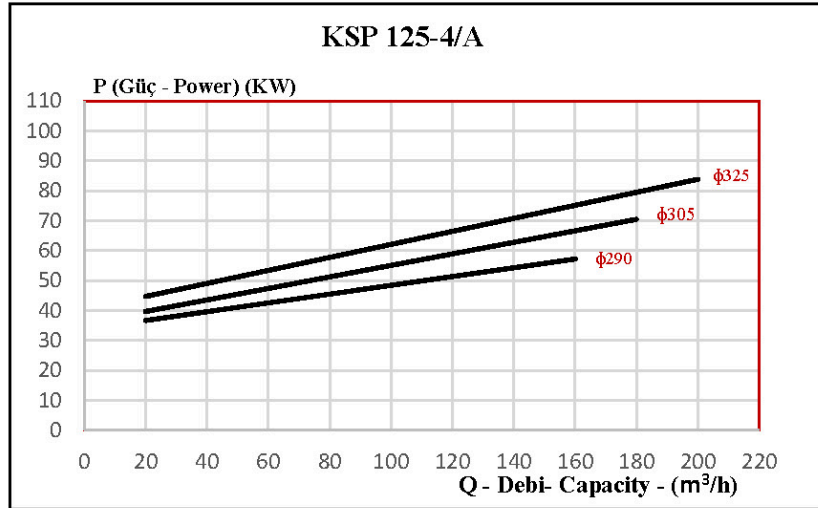
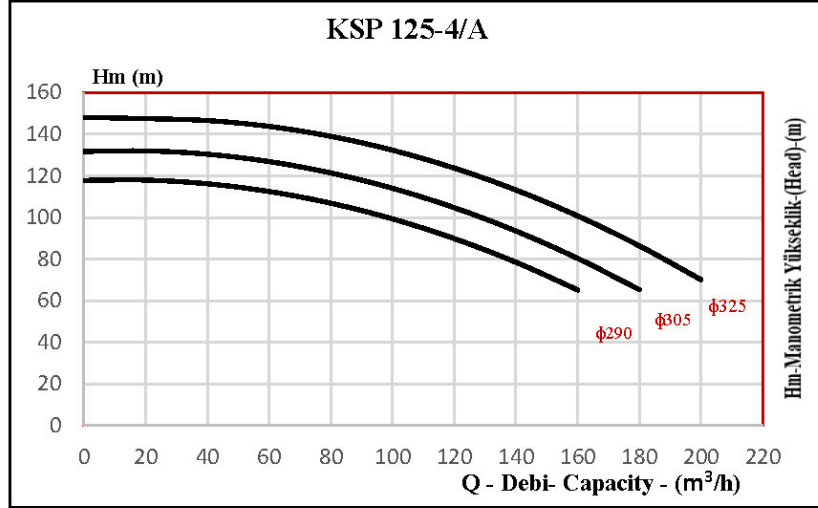
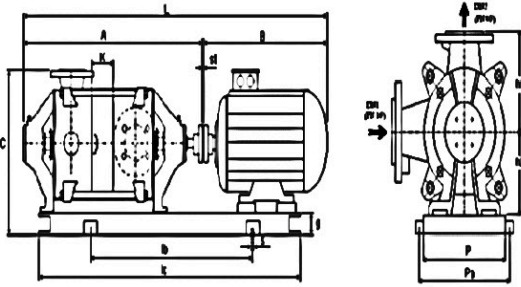

Pompa Tipi	KSP 125-4/A	
Kademe Sayısı	4	
Motor	HP	100 125
	Gövde	280 S4 280 M4
Flanşlar	DN1 (Emme) (mm)	150
	DN2 (Basma) (mm)	125
Boyut Ölçüsü (mm)	A	1425 1425
	B	958 1010
	C	850 850
	L	2383 2435
	lc	1787 1810
	lb	1387 1410
	K	115 115
	P	630 630
	Pa	690 690
	h1	375 375
h2	300 300	
Kaplin Ölçüsü (ϕ) (mm)	200	225
Ağırlık (kg)	1275	1362

KSP 125-3/A

Pompa Bilgileri			
Pompa Tipi	KSP 125-3/A	Sızdırmazlık	Yumuşak Salmastra
Çark Çapı (mm) ϕ	290-305-325	Yoğunluk (kg/m ³)	1
Sıvı Cinsi	Su	Sıcaklık	-1°C - +110°C

Motor Bilgileri	
Güç (HP)	75-100
Voltaj (Volt)	380
Faz	3
Frekans (Hz)	50-60
Devir (rpm) (d/dk)	1500

ϕ 290		ϕ 305		ϕ 325	
Q (m ³ /h)	Hm (m)	Q (m ³ /h)	Hm (m)	Q (m ³ /h)	Hm (m)
40	87	40	98	40	110
80	80	80	91	80	104
120	67	120	79	120	93
160	49	160	60	160	76
180	37	200	36	200	53
		220	39		

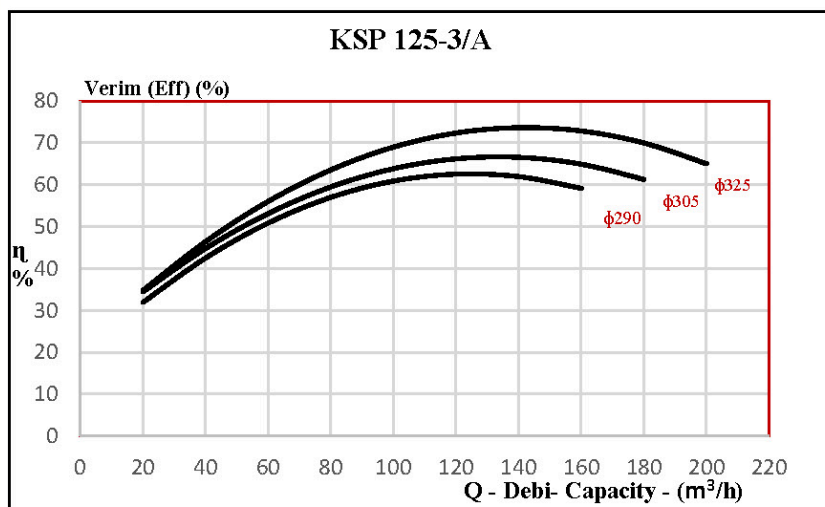
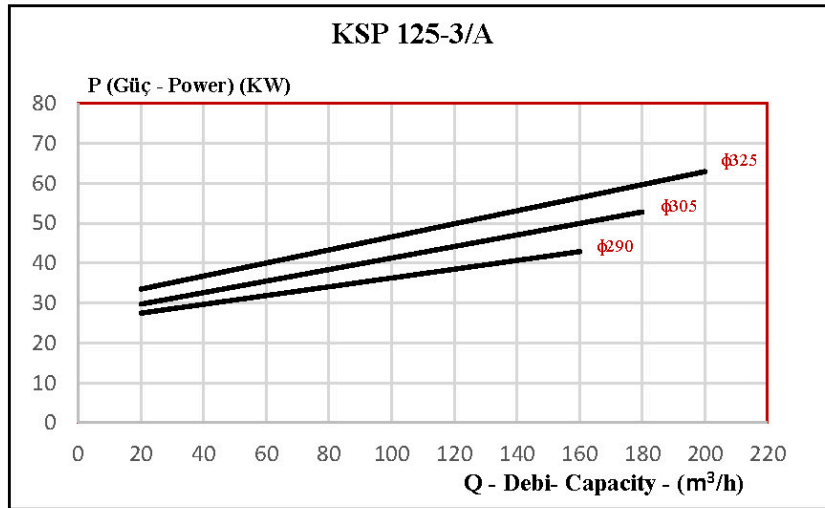
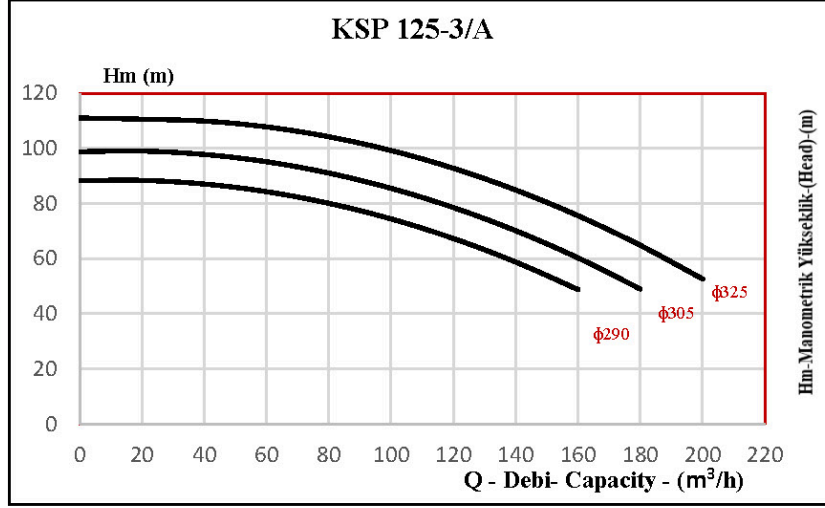
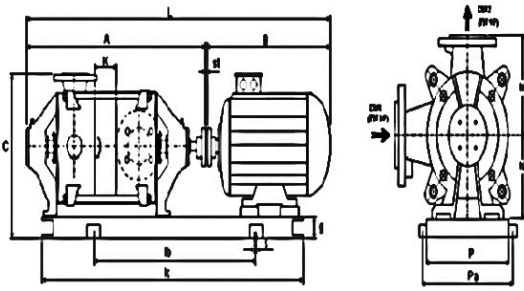

Pompa Tipi	KSP 125-3/A		
Kademe Sayısı	3		
Motor	HP	75	100
	Gövde	250 M4	280 S4
Flanşlar	DN1 (Emme) (mm)	150	
	DN2 (Basma) (mm)	125	
Boyut Ölçüsü (mm)	A	1195	1195
	B	900	958
	C	815	815
	L	2095	2208
	lc	1590	1680
	lb	1090	1280
	K	115	115
	P	550	550
	Pa	610	610
	h1	375	375
h2	300	300	
Kaplin Ölçüsü (ϕ) (mm)	180	200	
Ağırlık (kg)	1001	1106	

KSP 125-2/A

Pompa Bilgileri				Motor Bilgileri	
Pompa Tipi	KSP 125-2/A	Sızdırmazlık	Yumuşak Salmastra	Güç (HP)	60
Çark Çapı (mm) ϕ	290-305-325	Yoğunluk (kg/m ³)	1	Voltaj (Volt)	380
Sıvı Cinsi	Su	Sıcaklık	-1°C - +110°C	Faz	3
				Frekans (Hz)	50-60
				Devir (rpm) (d/dk)	1500

ϕ 290		ϕ 305		ϕ 325	
Q (m ³ /h)	Hm (m)	Q (m ³ /h)	Hm (m)	Q (m ³ /h)	Hm (m)
40	58	40	65	40	75
80	53	80	61	80	71
120	45	120	52	120	64
160	33	160	40	160	52
180	25	200	24	200	37
				220	28

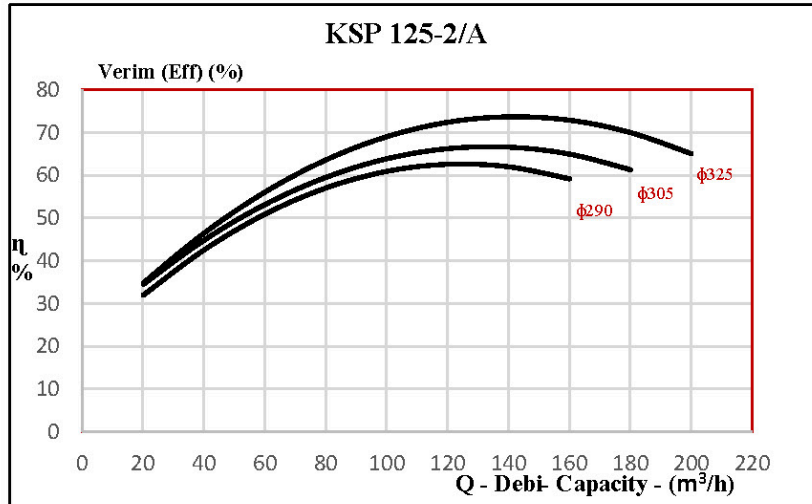
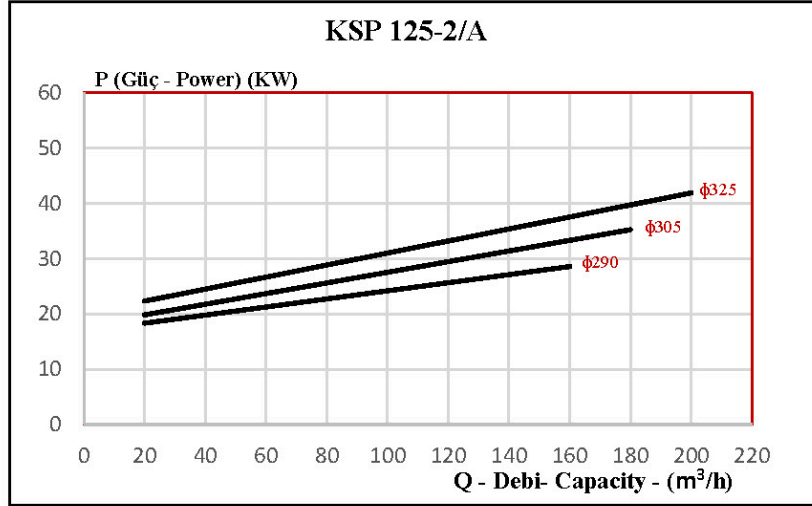
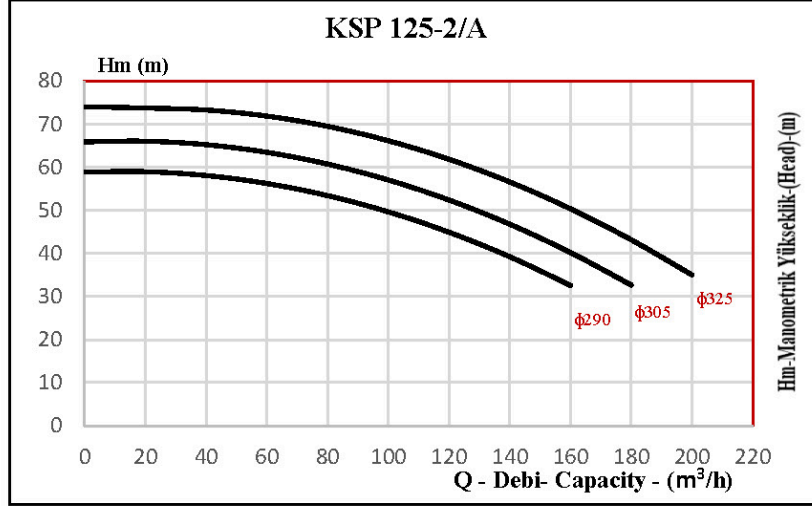
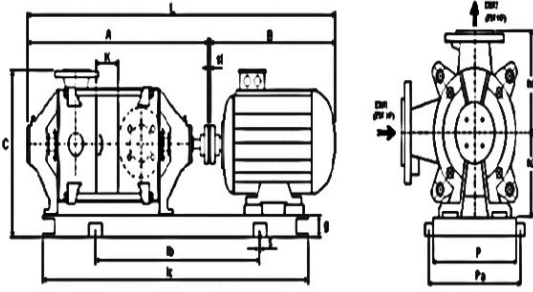

Pompa Tipi	KSP 125-2/A	
Kademe Sayısı	2	
Motor	HP	60
	Gövde	225 M4
Flanşlar	DN1 (Emme) (mm)	150
	DN2 (Basma) (mm)	125
Boyut Ölçüsü (mm)	A	965
	B	820
	C	815
	L	1830
	lc	1415
	lb	1015
	K	115
	P	550
	Pa	610
	h1	375
	h2	300
Kaplin Ölçüsü (ϕ) (mm)	160	
Ağırlık (kg)	815	

1450 d/dk

TEK KADEME İÇİN KARAKTERİSTİK EĞRİLER
Single Stage Performance Curves

